



BATTERY CHARGER MANUAL

TABLE OF CONTENTS

5

UPG 24V, 2.0A Sealed Lead-Acid Charger
Model numbers: 24BC2000T-1, 24BC2000T-2,
24BC2000T-3, 24BC2000T-4

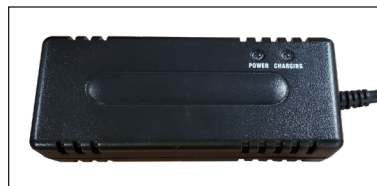

9

UPG 24V, 3.5A
Sealed Lead-Acid Charger
Model No: 24BC3500T-4



13

UPG 24V, 5.0A
Sealed Lead-Acid Charger
Model No: 24BC5000T-4



17

UPG 24V, 8.0A
Sealed Lead-Acid Charger
Model No: 24BC8000T-4



21

Battery Maximizer 24V, 2.0A
Lead-Acid Charger
Model No: EA1065-P

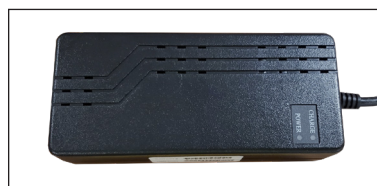
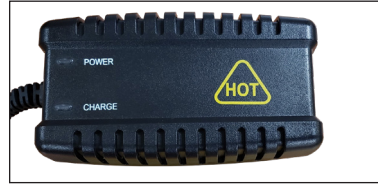

TABLE OF CONTENTS

25

Battery Maximizer 24V, 3.0A / 5.0A
Lead-Acid Charger for Victory® 10
Model Numbers: EA24030-9C, EA1148B



29

High Power Technology 24V, 2.0A
Battery Charger for Jazzy® Passport
Model No: HP0060W(L2)-M



31

Metco 29.2V, 2.5A
Lithium Ion Charger for Go-Go® Folding Scooter
Model No: NL07C-25HT



33

Intertek 29.4V, 2.5A
Lithium Ion Charger for Go-Go® Folding Scooter
Model No: LS-018C20-2402500

35

ACI SUPER POWER 24V, 5.0A
Lead-Acid Class II Battery Charger
Model No: ACI245000



TABLE OF CONTENTS

39

28.8V, 8.0A
Battery Charger
Model No: 4C24080A



41

36V / 2A
Battery Charger for iRIDE™ Scooter
Model No: HP1202L3



42

UPG 24V / 3.5A
Battery Charger for Go-Go® Endurance Scooter
/ Jazzy® EVO Series 613 Power Chair
Model No: 24BC3500L-1
Part No: ELE2008644



47

UPG 24V / 8A
Lithium Battery Charger
Model No: 24BC8000L-1
Part No: ELE2300934





SEALED LEAD-ACID CHARGER OWNER'S MANUAL

FOR MODEL NUMBER:

24BC2000T-1

24BC2000T-2

24BC2000T-3

24BC2000T-4

UNIVERSAL POWER GROUP
1720 Hayden Drive, Carrollton, TX 75006
Tel: (469) 892-1122 Fax: (469) 892-1123

SAVE THESE INSTRUCTIONS

This manual contains safety and operating instructions for your charger. Before using your charger, read all instructions for the charger, the battery to be charged, and the product that uses the batteries.

WARNINGS

- To reduce the risk of injury, charge only 24V, 7-18AH lead acid rechargeable batteries with the charger. Do not charge a non-rechargeable battery. Other types of batteries might burst, causing personal injury or other damage!
- Do not disassemble the charger. Have it serviced or repaired by qualified service personnel. Incorrect assembly can result in risk of electric shock or fire.
- Never use the charger as a DC power source for any electrical equipment.
- Never operate a charger with a damaged cord or plug. Inspect both input and output cords for any damage before using the charger.
- Never unplug a cord by pulling on the cord itself. Always grasp the plug when disconnecting the charger.
- For indoor use only. Do not expose charger to rain, snow or excessive moisture.
- Never charge a frozen battery.
- The battery must be placed in a well-ventilated area during charging.
- Do not use the charger while the equipment is operating.

CHARGING A BATTERY

Follow these steps to charge a battery:

1. Connect the DC output cable to the battery terminal receptacle.
2. Plug the charger power cord into the charger.
3. Plug the power cord into wall outlet.
4. The POWER LED and CHARGING LED light should be ON.
5. When batteries are fully charged, the CHARGING LED will be OFF. Unplug the charger from the wall, then the battery receptacle.

2 COLOR LEDs FOR STATUS INDICATION

A. POWER LED (dual color):

- Red color -Power on
- Green color -Charging a battery

B. CHARGING LED (Red color):

- LED on -Fast charge
- LED off -Float charge





PROTECTIONS

1. **Short-circuit protection** – protects the charger from short-circuit damage.
2. **Overcurrent protection** – protects the charger from over-current demand.
3. **Overvoltage protection** – protects the batteries from damage.
4. **Battery polarity reversal** – protects the charger and batteries against incorrectly installed batteries.

SPECIFICATIONS

1. Input Voltage 100 – 240Vac +/-10%
2. Input Frequency 50 – 60 Hz
3. Output Voltage
 - Fast Charge DC 29.6V
 - Float Charge DC 27.6V
4. Output Current
 - Fast Charge DC 2,000mA
 - Float Charge DC 500mA
5. Battery Capacity 7 – 18 AH (Suggested)

POWER CORD SELECTION

Model #	Plug Type	Input Voltage	Power Cord
24BC2000T-1	UL	AC 120V, 60Hz	
24BC2000T-2	GS	AC 230V, 50Hz	
24BC2000T-3	SAA	AC240V, 50Hz	
24BC2000T-4	BS	AC 230V, 50Hz	

Note: Charger comes with one power cord depending on the charger model number. Please refer to the table above for corresponding cord information.

AC CORD AND PLUG REQUIREMENTS

Cord rating: 120V, 1A, Type SJT, No. 18AWG (for use with 100-240VAC) 240V, 1A, Type SJT or equivalent, No. 18 AWG (for use with 200 - 240V AC)

Plug rating: Type NEMA5-15P (for use with 100-120VAC) Always use a plug that matches the type and rating of the AC outlet. Attachment plug with grounding pin (for use with 200 -240V AC)

Cord length: Min. 1.8m (6 feet). Max. 6.1 m (20 feet) including output cord.

Type: Must comply with requirements set out by the Safety Approval/Certification Organization of each country of use.

Note: Always use a plug that matches the type and rating of the AC outlet.

SAFETY STANDARDS: UU/cUL, CE, GS, c-Tick and SAA

THREE STAGE CHARGE CYCLE

An integrated circuit monitors and controls both the output voltage and current of the charger through three separate charge states:

- I. *A high current, fast charge state:* battery charges at 2,000mA fast charge current rate until battery voltage reaches 29.6V.
- II. *A topping charge state:* battery charges at 29.6V constant voltage and current begins to taper until current is less than 500mA.
- III. *A precision float charge state:* the charger changes to the float state and holds the battery voltage at 27.6V continuously. This allows the charger to remain connected to the batteries during periods of non-use, keeping the batteries in a state of full charge.

FCC STATEMENT

This device complies with Part 15 of the FCC rules. Operation is subject to the following two conditions: (1) This device may not cause harmful interference, and (2) This device must accept any interference received, including interference that may cause undesired operation.

NOTE: This equipment has been tested and found to comply with time limits for a Class B digital device, pursuant to Part 15 of the FCC rules. These limits are designed to provide reasonable protection against harmful interference in a residential installation. This equipment generates, uses and can radiate radio interference energy and, if not installed and used in accordance with the instructions, may cause harmful interference to radio communications. However, there is no guarantee that interference will not occur in a particular installation. If this equipment does cause harmful interference to radio or television reception, which can be determined by turning the equipment off and on, the user is encouraged to try to correct the interference by one or more of the following measures:

- Re-orient or relocate the receiving antenna.
- Increase the separation between the equipment and the receiver.
- Connect the equipment into an outlet or on a circuit different from that to which the receiver is connected.
- Consult the dealer or an experienced radio/TV technician for help.



OWNER'S MANUAL
24V 3.5A Sealed Lead-Acid Charger
Model No: 24BC3500T-4

SAFETY STANDARDS: UL, cUL, CE, GS, C-tick, SAA, FCC

FCC STATEMENT

This device complies with Part 15 of the FCC rules. Operation is subject to the following two conditions: (1) This device may not cause harmful interference, and (2) This device must accept any interference received, including interference that may cause undesired operation.

NOTE: This equipment has been tested and found to comply with the limits for a Class B digital device, pursuant to Part 15 of the FCC rules. These limits are designed to provide reasonable protection against harmful interference in a residential installation. This equipment generates, uses, and can radiate radio interference energy and, if not installed and used in accordance with the instructions, may cause harmful interference to radio communications. However, there is no guarantee that interference will not occur in a particular installation. If this equipment does cause harmful interference to radio or television reception, which can be determined by turning the equipment off and on, the user is encouraged to try to correct the interference by one or more of the following measures:

- Re-orient or relocate the receiving antenna.
- Increase the separation between the equipment and the receiver.
- Connect the equipment into an outlet or on a circuit different from that to which the receiver is connected.
- Consult the dealer or an experienced radio/TV technician for help.

IMPORTANT SAFETY INSTRUCTIONS

SAVE THESE INSTRUCTIONS:

This manual contains safety and operating instructions for your charger. Before using your charger, read all instructions and cautionary markings on the battery charger, and the product using the battery.

CAUTION: *To reduce the risk of injury, charge only AGM or GEL Sealed Lead-Acid batteries. Other types of batteries may burst, causing personal injury and damage.*

WARNINGS:

- This charger is not intended for use by persons with reduced physical, sensory or mental capabilities, or lack of experience and knowledge, unless under direct supervision. Do not allow children to operate the charger unsupervised. Keep out of reach of children.
- Do not disassemble the charger. Have it serviced or repaired by qualified service personnel. Incorrect assembly can result in risk of electric shock or fire.
- Never use the charger as a DC power source for any electrical equipment.
- Never operate a charger with a damaged cord or plug. Inspect both input and output cords for any damage before using the charger.
- Never unplug a cord by pulling on the cord itself. Always grasp the plug when disconnecting the charger.
- For indoor use only. Do not expose charger to rain, snow or excessive moisture.
- Never charge a frozen battery.
- The battery must be placed in a well-ventilated area during charging.

CHARGING A BATTERY:

Follow these steps to charge a battery:

1. Check battery-type selection switch to match your batteries - AGM or GEL. The default selection for this charger is AGM.
2. Connect the charger DC output cable to the battery charge receptacle.
3. Plug the charger power cord into the charger.
4. Plug the power cord into wall outlet.
5. The POWER LED and CHARGING LED light should be ON.
6. When batteries are fully charged, the CHARGING LED will be steady GREEN. Unplug the charger from the wall, then the battery receptacle.

LED INDICATORS:

2 color LEDs for status indication:

A. POWER LED (CLEAR lens):

Red Color – Power On

B. CHARGING/ FAULT LED (CLEAR LENS-DUAL Color):

RED color STEADY ON – Fast Charge

GREEN color FLASHING – Float Charge

GREEN color STEADY – Charge finished

RED color FLASHING – FAULT

FAULT CODES

INDICATION CHARGE/FAULT - Red LED		FAULT
1	Off	No batteries - Voltage < 9V
2	Continuous flashing	12 hour charge timed out
3	1 flash every 3 seconds	Battery voltage < 14V
4	2 flashes every 3 seconds	Batteries are connected in reverse polarity
5	3 flashes every 3 seconds	Overvoltage from batteries
6	4 flashes every 3 seconds	Overcurrent from charger

THREE STAGE CHARGE CYCLE:

An Electronic Control Module (ECM) controls both the output voltage and current of the charger through three separate charge states:

1. **A high current, fast charge state:** Battery charges at 3,500mA fast charge current rate until battery voltage reaches peak voltage.
2. **A topping charge state:** Battery charges at peak constant voltage and current begins to fall until current is less than 700mA.
3. **A precision float charge state:** The charger changes to the float state and holds the battery voltage at continuous float voltage. This allows the charger to remain connected to the batteries during periods of non-use, keeping the batteries in a state of full charge.
4. **Charger cut-off:** To comply with mandate of DOE this charger automatically cuts off after 20 hours of continuous operation, and CHARGE STATUS LED turns off. It is designed with auto restart to keep batteries charged.

SAFETY FEATURES:

1. **Short-circuit Protection** – protects the charger from short-circuit damage.
2. **Overcurrent Protection** – protects the charger from overcurrent demand.
3. **Overvoltage Protection** – protects the batteries from damage.
4. **Battery Polarity Reversal** – protects the charger and batteries against incorrectly installed batteries.
5. **Low Battery Voltage** – when the battery is under 14V, the charger will not engage.

SPECIFICATIONS:

1	Input Voltage	100 – 240Vac +/-10%						
2	Input Frequency	50–60 Hz						
3	Output Voltage Fast Charge (Bulk) Float	<table style="width: 100%; border: none;"> <tr> <td style="text-align: center;">AGM</td> <td style="text-align: center;">GEL</td> </tr> <tr> <td style="text-align: center;">DC 29.6V +/- 0.2V</td> <td style="text-align: center;">DC 28.6V +/- 0.2V</td> </tr> <tr> <td style="text-align: center;">DC 27.4V +/- 0.4V</td> <td style="text-align: center;">DC 26.6V +/- 0.4V</td> </tr> </table>	AGM	GEL	DC 29.6V +/- 0.2V	DC 28.6V +/- 0.2V	DC 27.4V +/- 0.4V	DC 26.6V +/- 0.4V
AGM	GEL							
DC 29.6V +/- 0.2V	DC 28.6V +/- 0.2V							
DC 27.4V +/- 0.4V	DC 26.6V +/- 0.4V							
4	Output Current Fast Charge (Bulk)	DC 3,500mA						
5	Battery Capacity	12-35 Ah (Suggested)						
6	Operating Temperature	-13°F/-25°C to +122°F/50°C						
7	Storage Temperature	-13°F/-25°C to +140°F/60°C						
8	Power Supply Cord	SJT, 18AWGX3C, 300V, 105°C						

TROUBLESHOOTING

FAULT CONDITION	CAUSE
Charging will not start; Charge/Fault LED not on	1) Batteries not connected 2) Battery voltage less than 14V
Charge complete; (Green) LED is not on; Fault (Red) LED is blinking continuously	1) Charger is too small for batteries 2) Possible bad battery
Charging doesn't start; Charge/Fault (Red) LED is blinking once every 3 sec.	Battery voltage is less than 14V
Charge/Fault (Red) LED is blinking 2 times every 3 sec.	Batteries are in reverse polarity to charger
Charge/Fault (Red) LED is blinking 3 times every 3 sec.	1) Charger has exceeded 30V output 2) Bad batteries
Charge/Fault (Red) LED is blinking 4 times every 3 sec.	1) Charger has exceeded its rated charge current 2) Bad batteries

LIMITED WARRANTY STATEMENT

Universal Power Group (UPG) warrants your unit to be free from defects in material and workmanship for a period of 1 year from the date of sale to the original user or purchaser. This warranty is non-transferable. If your unit malfunctions or fails within the 1 year period because of a defect in material or workmanship, we will replace or repair the unit. Replacement will be made with a new or re-manufactured product or component. If the product is no longer available, replacement may be made with a similar product of equal or greater value.

This warranty excludes malfunctions or failure of your unit caused by repairs made by an unauthorized person, mishandling, modifications, normal wear, unreasonable use, or damage to the product.

This warranty is in lieu of all other express warranties. The duration of any implied warranty, including but not limited to any implied warranty of merchantability or fitness for a particular purpose, made in respect to your unit is limited to the period of the express warranty set forth above.

In no event shall UPG be liable for consequential or incidental damages. Some states do not allow limitations on the length of implied warranty or the exclusion or limitations of incidental or consequential damages, so the above limitations or exclusions may not apply to you. This warranty gives you specific legal rights and you may also have other rights, which vary from state to state.

If you have technical questions, please send inquiries to:

technicalsupport@upgi.com

Warranty Process

Please contact your retailer or place of purchase for warranty service and instructions.
A proof of purchase will be required.



OWNER'S MANUAL
24V 5.0A Sealed Lead-Acid Charger
Model No: 24BC5000T-4

SAFETY STANDARDS: UL, cUL, CE, GS, C-tick, SAA, FCC

FCC STATEMENT

This device complies with Part 15 of the FCC rules. Operation is subject to the following two conditions: (1) This device may not cause harmful interference. and (2) This device must accept any interference received, including interference that may cause undesired operation.

NOTE: This equipment has been tested and found to comply with the limits for a Class B digital device, pursuant to Part 15 of the FCC rules. These limits are designed to provide reasonable protection against harmful interference in a residential installation. This equipment generates, uses, and can radiate radio interference energy and, if not installed and used in accordance with the instructions, may cause harmful interference to radio communications. However, there is no guarantee that interference will not occur in a particular installation. If this equipment does cause harmful interference to radio or television reception, which can be determined by turning the equipment off and on, the user is encouraged to try to correct the interference by one or more of the following measures:

- Re-orient or relocate the receiving antenna.
- Increase the separation between the equipment and the receiver.
- Connect the equipment into an outlet or on a circuit different from that to which the receiver is connected.
- Consult the dealer or an experienced radio/TV technician for help.

IMPORTANT SAFETY INSTRUCTIONS

SAVE THESE INSTRUCTIONS:

This manual contains safety and operating instructions for your charger. Before using your charger, read all instructions and cautionary markings on the battery charger, and the product using the battery.

CAUTION: *To reduce the risk of injury, charge only AGM or GEL Sealed Lead-Acid batteries. Other types of batteries may burst, causing personal injury and damage.*

WARNINGS:

- This charger is not intended for use by persons with reduced physical, sensory or mental capabilities, or lack of experience and knowledge, unless under direct supervision. Do not allow children to operate the charger unsupervised. Keep out of reach of children
- Do not disassemble the charger. Have it serviced or repaired by qualified service personnel. Incorrect assembly can result in risk of electric shock or fire.
- Never use the charger as a DC power source for any electrical equipment.
- Never operate a charger with a damaged cord or plug. Inspect both input and output cords for any damage before using the charger.
- Never unplug a cord by pulling on the cord itself. Always grasp the plug when disconnecting the charger.
- For indoor use only. Do not expose charger to rain, snow or excessive moisture.
- Never charge a frozen battery.
- The battery must be placed in a well-ventilated area during charging.

CHARGING A BATTERY:

Follow these steps to charge a battery:

1. Check battery-type selection switch to match your batteries - AGM or GEL The default selection for this charger is AGM.
2. Connect the charger DC output cable to the battery charge receptacle.
3. Plug the charger power cord into the charger.
4. Plug the power cord into wall outlet.
5. The POWER LED and CHARGING LED light should be ON.
6. When batteries are fully charged, the CHARGING LED will be steady GREEN. Unplug the charger from the wall, then the battery receptacle.

LED INDICATORS:

2 color LEDs for status indication:

A. POWER LED (CLEAR lens):

Red Color – Power On

B. CHARGING/ FAULT LED (CLEAR LENS-DUAL Color):

RED color STEADY ON – Fast Charge

GREEN color FLASHING – Float Charge

GREEN color STEADY – Charge finished

RED color FLASHING – FAULT

FAULT CODES

INDICATION CHARGE/FAULT - Red LED		FAULT
1	LED is off.	No batteries - Voltage < 9V
2	LED - continuous flashing	12 hour charge timed out
3	LED - 1 flash every 3 seconds	Battery voltage < 14V
4	LED - 2 flashes every 3 seconds	Batteries are connected in reverse polarity
5	LED - 3 flashes every 3 seconds	Overvoltage from batteries
6	LED - 4 flashes every 3 seconds	Overcurrent from charger

THREE STAGE CHARGE CYCLE:

An Electronic Control Module (ECM) controls both the output voltage and current of the charger through three separate charge states:

1. **A high current, fast charge state:** Battery charges at 5,000mA fast charge current rate until battery voltage reaches peak voltage.
2. **A topping charge state:** Battery charges at peak constant voltage and current begins to fall until current is less than 1A.
3. **A precision float charge state:** The charger changes to the float state and holds the battery voltage at continuous float voltage. This allows the charger to remain connected to the batteries during periods of non-use, keeping the batteries in a state of full charge.
4. **Charger cut-off:** To comply with mandate of DOE this charger automatically cuts off after 20 hours of continuous operation. It is designed with auto restart to keep batteries charged.

SAFETY FEATURES:

1. **Short-circuit protection** – protects the charger from short-circuit damage.
2. **Overcurrent protection** – protects the charger from overcurrent demand.
3. **Overvoltage protection** – protects the batteries from damage.
4. **Battery polarity reversal** – protects the charger and batteries against incorrectly installed batteries.
5. **Low battery voltage** – when the battery is under 14V, the charger will not engage.

NOTE: COMPLETE battery charge is NOT achieved until battery has charged 15 hours.

SPECIFICATIONS:

1	Input Voltage	100 – 240Vac +/-10%						
2	Input Frequency	50–60 Hz						
3	Output Voltage Fast Charge (Bulk) Float	<table style="width: 100%; border: none;"> <tr> <td style="text-align: center;">AGM</td> <td style="text-align: center;">GEL</td> </tr> <tr> <td style="text-align: center;">DC 29.6V +/- 0.2V</td> <td style="text-align: center;">DC 28.6V +/- 0.2V</td> </tr> <tr> <td style="text-align: center;">DC 27.3V +/- 0.4V</td> <td style="text-align: center;">DC 26.6V +/- 0.4V</td> </tr> </table>	AGM	GEL	DC 29.6V +/- 0.2V	DC 28.6V +/- 0.2V	DC 27.3V +/- 0.4V	DC 26.6V +/- 0.4V
AGM	GEL							
DC 29.6V +/- 0.2V	DC 28.6V +/- 0.2V							
DC 27.3V +/- 0.4V	DC 26.6V +/- 0.4V							
4	Output Current Fast Charge (Bulk)	DC 5,000mA						
5	Battery Capacity	18-50 Ah (Suggested)						
6	Operating Temperature	+32°F/0°C to +104°F/40°C						
7	Storage Temperature	-4°F/-20°C to +140°F/60°C						
8	Power Supply Cord	SJT, 18AWGX3C, 300V, 105°C						

TROUBLESHOOTING

FAULT CONDITION	CAUSE
Charging will not start; Charge/Fault LED not on	1) Batteries not connected 2) Battery voltage less than 14V
Charge Complete; (Green) LED is not on; Fault (Red) LED is blinking continuously	1) Charger is too small for batteries 2) Possible bad battery
Charging doesn't start; Charge/Fault (Red) LED is blinking once every 3 seconds	Battery voltage is less than 14V
Charge/Fault (Red) LED is blinking 2 times every 3 seconds	Batteries are in reverse polarity to charger
Charge/Fault (Red) LED is blinking 3 times every 3 seconds	1) Charger has exceeded 30V output 2) Bad batteries
Charge/Fault (Red) LED is blinking 4 times every 3 seconds	1) Charger has exceeded its rated charge current 2) Bad batteries

LIMITED WARRANTY STATEMENT

Universal Power Group (UPG) warrants your unit to be free from defects in material and workmanship for a period of 1 year from the date of sale to the original user or purchaser. This warranty is non-transferable. If your unit malfunctions or fails within the 1 year period because of a defect in material or workmanship, we will replace or repair the unit. Replacement will be made with a new or re-manufactured product or component. If the product is no longer available, replacement may be made with a similar product of equal or greater value.

This warranty excludes malfunctions or failure of your unit caused by repairs made by an unauthorized person, mishandling, modifications, normal wear, unreasonable use, or damage to the product.

This warranty is in lieu of all other express warranties. The duration of any implied warranty, including but not limited to any implied warranty of merchantability or fitness for a particular purpose, made in respect to your unit is limited to the period of the express warranty set forth above.

In no event shall UPG be liable for consequential or incidental damages. Some states do not allow limitations on the length of implied warranty or the exclusion or limitations of incidental or consequential damages, so the above limitations or exclusions may not apply to you. This warranty gives you specific legal rights and you may also have other rights, which vary from state to state.

If you have technical questions, please send inquiries to:

technicalsupport@upgi.com

Warranty Process

Please contact your retailer or place of purchase for warranty service and instructions.
A proof of purchase will be required.



OWNER'S MANUAL
24V 8.0A Sealed Lead-Acid Charger
Model No: 24BC8000T-4

SAFETY STANDARDS: UL, cUL, CE, GS, C-tick, SAA, FCC

FCC STATEMENT

This device complies with Part 15 of the FCC rules. Operation is subject to the following two conditions: (1) This device may not cause harmful interference. and (2) This device must accept any interference received, Including Interference that may cause undesired operation.

NOTE: This equipment has been tested and found to comply with the limits for a Class B digital device, pursuant to Part 15 of the FCC rules. These limits are designed to provide reasonable protection against harmful interference in a residential installation. This equipment generates, uses, and can radiate radio interference energy and, if not installed and used in accordance with the instructions, may cause harmful interference to radio communications. However, there is no guarantee that interference will not occur in a particular installation. If this equipment does cause harmful interference to radio or television reception, which can be determined by turning the equipment off and on, the user is encouraged to try to correct the interference by one or more of the following measures:

- Re-orient or relocate the receiving antenna.
- Increase the separation between the equipment and the receiver.
- Connect the equipment into an outlet or on a circuit different from that to which the receiver is connected.
- Consult the dealer or an experienced radio/TV technician for help.

IMPORTANT SAFETY INSTRUCTIONS

SAVE THESE INSTRUCTIONS:

This manual contains safety and operating instructions for your charger. Before using your charger, read all instructions and cautionary markings on the battery charger, and the product using the battery.

CAUTION: *To reduce the risk of injury, charge only AGM or GEL Sealed Lead-Acid batteries. Other types of batteries may burst, causing personal injury and damage.*

WARNINGS:

- This charger is not intended for use by persons with reduced physical, sensory or mental capabilities, or lack of experience and knowledge, unless under direct supervision. Do not allow children to operate the charger unsupervised. Keep out of reach of children
- Do not disassemble the charger. Have it serviced or repaired by qualified service personnel. Incorrect assembly can result in risk of electric shock or fire.
- Never use the charger as a DC power source for any electrical equipment.
- Never operate a charger with a damaged cord or plug. Inspect both input and output cords for any damage before using the charger.
- Never unplug a cord by pulling on the cord itself. Always grasp the plug when disconnecting the charger.
- For indoor use only. Do not expose charger to rain, snow or excessive moisture.
- Never charge a frozen battery.
- The battery must be placed in a well-ventilated area during charging.

CHARGING A BATTERY:

Follow these steps to charge a battery:

1. Check battery-type selection switch to match your batteries - AGM or GEL.
2. Connect the charger DC output cable to the battery charge receptacle.
3. Plug the charger power cord into the charger.
4. Plug the power cord into wall outlet.
5. The POWER LED and CHARGING LED light should be ON.
6. When batteries are fully charged, the CHARGING LED will be steady GREEN.
Unplug the charger from the wall, then the battery receptacle.

LED INDICATORS:

2 color LEDs for status indication:

A. POWER LED (CLEAR lens):

Red Color – Power On

B. CHARGING/ FAULT LED (CLEAR LENS-DUAL Color):

RED color STEADY ON – Fast Charge

GREEN color FLASHING – Float Charge

GREEN color STEADY – Charge finished

RED color FLASHING – FAULT

FAULT CODES

INDICATION CHARGE/FAULT - Red LED		FAULT
1	LED is off.	No batteries - Voltage < 9V
2	LED - continuous flashing	12 hour charge timed out
3	LED - 1 flash every 3 seconds	Battery voltage < 14V
4	LED - 2 flashes every 3 seconds	Batteries are connected in reverse polarity
5	LED - 3 flashes every 3 seconds	Overvoltage from batteries
6	LED - 4 flashes every 3 seconds	Overcurrent from charger

THREE-STAGE CHARGE CYCLE:

An Electronic Control Module (ECM) controls both the output voltage and current of the charger through three separate charge states:

1. **A high current, fast charge state:** Battery charges at 8,000mA fast charge current rate until battery voltage reaches peak voltage.
2. **A topping charge state:** Battery charges at peak constant voltage and current begins to fall until current is less than 1.6A.
3. **A precision float charge state:** The charger changes to the float state and holds the battery voltage at continuous float voltage. This allows the charger to remain connected to the batteries during periods of non-use, keeping the batteries in a state of full charge.
4. **Charger cut-off:** To comply with mandate of DOE this charger automatically cuts off after 20 hours of continuous operation. It is designed with auto restart to keep batteries charged.

SAFETY FEATURES:

1. **Short-circuit protection** – protects the charger from short-circuit damage.
2. **Overcurrent protection** – protects the charger from overcurrent demand.
3. **Overvoltage protection** – protects the batteries from damage.
4. **Battery polarity reversal** – protects the charger and batteries against incorrectly installed batteries.
5. **Low battery voltage** – when the battery is under 14V, the charger will not engage.

NOTE: COMPLETE battery charge is NOT achieved until battery has charged for 15 hours.

SPECIFICATIONS:

1	Input Voltage	100 – 240Vac +/-10%						
2	Input Frequency	50–60 Hz						
3	Output Voltage Fast Charge (Bulk) Float	<table style="width: 100%; border: none;"> <tr> <td style="text-align: center;">AGM</td> <td style="text-align: center;">GEL</td> </tr> <tr> <td style="text-align: center;">DC 29.6V +/- 0.2V</td> <td style="text-align: center;">DC 28.6V +/- 0.2V</td> </tr> <tr> <td style="text-align: center;">DC 27.3V +/- 0.4V</td> <td style="text-align: center;">DC 26.7V +/- 0.4V</td> </tr> </table>	AGM	GEL	DC 29.6V +/- 0.2V	DC 28.6V +/- 0.2V	DC 27.3V +/- 0.4V	DC 26.7V +/- 0.4V
AGM	GEL							
DC 29.6V +/- 0.2V	DC 28.6V +/- 0.2V							
DC 27.3V +/- 0.4V	DC 26.7V +/- 0.4V							
4	Output Current Fast Charge (Bulk)	DC 8,000mA						
5	Battery Capacity	24-85 Ah (Suggested)						
6	Operating Temperature	+32°F/0°C to +104°F/40°C						
7	Storage Temperature	-4°F/-20°C to +140°F/60°C						
8	Power Supply Cord	SJT, 18AWGX3C, 300V, 105°C						

TROUBLESHOOTING

FAULT CONDITION	CAUSE
Charging will not start; Charge/Fault LED not on	1) Batteries not connected 2) Battery voltage less than 14V
Charge Complete; (Green) LED is not on; Fault (Red) LED is blinking continuously	1) Charger is too small for batteries 2) Possible bad battery
Charging doesn't start; Charge/Fault (Red) LED is blinking once every 3 sec.	Battery voltage is less than 14V
Charge/Fault (Red) LED is blinking 2 times every 3 sec.	Batteries are in reverse polarity to charger
Charge/Fault (Red) LED is blinking 3 times every 3 sec.	1) Charger has exceeded 30V output 2) Bad batteries
Charge/Fault (Red) LED is blinking 4 times every 3 sec.	1) Charger has exceeded its rated charge current 2) Bad batteries

LIMITED WARRANTY STATEMENT

Universal Power Group (UPG) warrants your unit to be free from defects in material and workmanship for a period of 1 year from the date of sale to the original user or purchaser. This warranty is non-transferable. If your unit malfunctions or fails within the 1 year period because of a defect in material or workmanship, we will replace or repair the unit. Replacement will be made with a new or re-manufactured product or component. If the product is no longer available, replacement may be made with a similar product of equal or greater value.

This warranty excludes malfunctions or failure of your unit caused by repairs made by an unauthorized person, mishandling, modifications, normal wear, unreasonable use, or damage to the product.

This warranty is in lieu of all other express warranties. The duration of any implied warranty, including but not limited to any implied warranty of merchantability or fitness for a particular purpose, made in respect to your unit is limited to the period of the express warranty set forth above.

In no event shall UPG be liable for consequential or incidental damages. Some states do not allow limitations on the length of implied warranty or the exclusion or limitations of incidental or consequential damages, so the above limitations or exclusions may not apply to you. This warranty gives you specific legal rights and you may also have other rights, which vary from state to state.

If you have technical questions, please send Inquiries to:

technicalsupport@upgi.com

Warranty Process

Please contact your retailer or place of purchase for warranty service and instructions.
A proof of purchase will be required.

**Battery Maximizer
Lead-Acid Battery Charger
Instruction Manual**

EA1065-P
24 Volt

VRLA / SLA / AGM / Gel

Fully Automatic

SAVE THESE INSTRUCTIONS

This manual contains important safety
and operating instructions.

INTRODUCTION

The Battery Maximizer **EA1065-P** 24 volt battery charger is a fully automatic, multi-stage full switching charger. It is designed to properly charge VRLA / SLA / AGM / Gel lead-acid batteries without having to worry about overcharging. It may be used in all parts of the world with its advanced universal AC input (110 or 220VAC). The dual LEDs let you know the condition of the battery and if there are problems.

INSTRUCTIONS:

LED Function

LED	CONDITION
Power • (green) Charge • (red)	AC connection Batteries fast charging
Power • (green) Charge • (green)	AC connection Battery fully charged
Power • (red) Charge • (off)	Error; short circuit, leads reversed, battery disconnected or battery voltage less than 9VDC

CAUTION: If the charge LED remains red for more than 24 hours, unplug charger from AC power and check the batteries. There may be a problem with the batteries. Call for service if needed.

CHARGING: Before use, read all instructions and cautionary markings on charger, battery and mobility aid.

Turn off all accessories on mobility aid device.

Place charger in a safe, clean environment on a hard surface (floor or desktop).

Plug XLR connector to appropriate port on the mobility aid.

Plug the charger to AC power.

The charger will begin charging automatically. If the Green Power LED does not illuminate, check the connections.

Note that if the battery voltage is less than 9VDC, then the charger will not charge. The batteries may not be connected correctly or have been over-discharged. Battery replacement may be necessary. Have the unit inspected by an authorized service center.

SPECIFICATIONS

Input

100–240 VAC, 50/60Hz

Output

24 Volt DC Battery Charger

2A charge current

Dimensions:

Height 1.60 in.

Width 2.70 in.

Length 6.06 in.

Weight 0.93 lbs.

Safety Listings

UL, CUL, CE

FCC Class B

CHARACTERISTICS

Universal AC input 100–240V, 50-60Hz

Charge condition:

Fast charge 29.4VDC

Absorption 29.4VDC

Float charge 27.6VDC

Reverse polarity protection

Overvoltage protection

Short circuit protection

Lightweight

small size

IMPORTANT SAFETY INSTRUCTIONS

Rev. F

CAUTION: For use with LEAD-ACID batteries only
VRLA, SLA, AGM, Gel

For indoor use only.

WARNING: To reduce risk of fire and electric shock, install in a temperature and humidity controlled indoor area, free from dust and conductive contaminants. Disconnect from AC power before cleaning. Make sure batteries are clean and properly connected. Keep away from heat, fire and water.

There are no user serviceable parts on this charger. If there is a problem or the cords have been damaged, it must be serviced by qualified service personnel.

This device complies with Part 15 of the FCC rules. Operation is subject to the following 2 conditions: (1) This device may not cause harmful interference, and (2) this device must accept any interference received, including interference that may cause undesired operation.

WARRANTY

The warranty is for a period of 1 year from date of purchase and covers manufacturer's defects. The charger will be replaced or repaired at the manufacturer's discretion. Proof of purchase is required.

Battery Maximizer
info@batterymaximizer.com

**Battery Maximizer
Lead-Acid Battery Charger
Instruction Manual**

ELECHG1016
3 Amp off-board (Victory 10)

EA24030-9C
24 Volt

VRLA / SLA / AGM / Gel

Fully Automatic

SAVE THESE INSTRUCTIONS
This manual contains important safety
and operating instructions.

INTRODUCTION

The Battery Maximizer **A24030-9C** 24 volt battery charger is a fully automatic, multi-stage full switching charger. It is designed to properly charge VRLA / SLA / AGM / Gel lead-acid batteries without having to worry about overcharging. It may be used in all parts of the world with its advanced universal AC input (110 or 220VAC). The dual LEDs let you know the condition of the battery and if there are problems.

INSTRUCTIONS:

LED Function

LED	CONDITION
Power • (green) Charge • (red)	AC connection Batteries fast charging
Power • (green) Charge • (green)	AC connection Battery fully charged
Power • (red) Charge • (off)	Error; short circuit, leads reversed, battery disconnected or battery voltage less than 5VDC

CAUTION: If the charge LED remains red for more than 24 hours, unplug charger from AC power and check the batteries. There may be a problem with the batteries. Call for service if needed.

CHARGING: Before use, read all instructions and cautionary markings on charger, battery and mobility aid.

Turn off all accessories on mobility aid device.

Place charger in a safe and clean environment on a hard surface (floor or desktop).

Plug connector to appropriate port on the mobility aid.

Plug the charger into AC power.

The charger will begin charging automatically. If the Green Power LED does not illuminate, check the connections. Note: If the battery voltage is less than 5VDC, then the charger will not charge. The batteries may not be connected correctly or have been overdischarged.

Battery replacement may be necessary. Have the unit inspected by an authorized service center.

INHIBIT FUNCTION

The inhibitor pin of output connector will be low level for inhibit function when AC voltage applies to this charger.

SPECIFICATIONS

Input

100–240 VAC, 50/60Hz

Output

24 Volt DC Battery Charger

3A charge current

Dimensions:

Height 1.89 in.

Width 3.15 in.

Length 5.89 in.

Weight 1.324 lbs.

Safety Listings

UL, CUL, CE

FCC Class B

CHARACTERISTICS

Universal AC input 100–240V, 50-60Hz

Charge condition:

Fast charge 29.4VDC

Absorption 29.4VDC

Float charge 27.6VDC

Reverse polarity protection

Overvoltage protection

Short circuit protection

Lightweight

small size

IMPORTANT SAFETY INSTRUCTIONS

Rev. F

CAUTION: For use with LEAD-ACID batteries only
VRLA, SLA, AGM, Gel

For indoor use only.

WARNING: To reduce risk of fire and electric shock, install in a temperature-controlled and humidity-controlled indoor area, free from dust and conductive contaminants. Disconnect from AC power before cleaning. Make sure batteries are clean and properly connected. Keep away from heat, fire and water.

There are no user serviceable parts on this charger. If there is a problem or the cords have been damaged, it must be serviced by qualified service personnel.

This device complies with Part 15 of the FCC rules. Operation is subject to the following 2 conditions: (1) This device may not cause harmful interference, and (2) this device must accept any interference received, including interference that may cause undesired operation.

WARRANTY

The warranty is for a period of 1 year from date of purchase and covers manufacturer's defects. The charger will be replaced or repaired at the manufacturer's discretion. Proof of purchase is required.

Battery Maximizer
info@batterymaximizer.com



HIGH POWER TECHNOLOGY (KunShan) INC

Battery Charger Instructions

HP0060W Series

HP0060W BATTERY CHARGER INSTRUCTIONS

1. OPERATING INSTRUCTIONS

- (1) Make sure the power cord, charger and battery connector are in good condition.
- (2) Make sure the output voltage of the charger is the same as the connecting battery.
- (3) Connect the plug of the charger with the battery, and then plug the AC power plug into an outlet.

2. LED INDICATIONS

Red light on: Power on, disconnect with the battery

Orange light on: Charging

Green light on: Fully charged

3. TROUBLESHOOTING

- (1) RED light is off when power is on:

Check if the input power cord of the charger has been plugged into the socket and if electricity passes from the outlet. If **YES**, please send the charger for repair.

- (2) ORANGE light is off during charging:

Check if the charger and battery connectors are correctly connected and if they are in good connection. If the battery is not fully charged, the battery may be defective.

- (3) ORANGE light turns to GREEN immediately:

Check to see if the battery is fully charged. If not, the charger maybe defective. Please send the charger back to the manufacturer for repair.

4. CAUTION

- (1) For indoor use only. Do not expose to rain.
- (2) Please switch off the power supply before removing the charger from the battery.
- (3) Do not get close to explosive gases or sparks and put the charger in a well-ventilated area during charging.
- (4) Use the charger only with 24V lithium batteries.



Specification of Li-ion Charger (Model NL07C-25HT)

DESCRIPTION:

NL07C-25HT is a smart charger specially designed for Li-ion battery pack composed cells in series.

ELECTRICAL SPECIFICATIONS:

1. Input: 100-240VAC, 50/60 Hz. Output: 29.05V \pm 0.2V 2.5A_{dc} \pm 10%
2. Charger output: The charger is preset by factory for charging 7 cells Li-ion battery pack.
Its charging mode:
 - (1) Constant current (CC) mode : at beginning of charging, an 2.5A_{dc} \pm 10% (1(ave)) constant charging current to charge the pack until the pack voltage reaches to 29.05V \pm 0.2V.
 - (2) Constant Voltage (CV) mode : the output will keep 29.05V \pm 0.2V constant through the end of charging.
 - (3) Pre-charge state: When battery voltage is lower than 21V \pm 1V. will start the pre-charge first. The charge current is 30% of CC charge current: 0.75A_{dc} \pm 10%.

3. The indicator signal chart:

LED 1	LED 2	Condition / Indicators
OFF	ON	Power ON (power ON by plugging in AC source and without battery) Flashing three times then ON
ON	OFF	Constant current mode
ON	OFF	Constant voltage mode
ON	ON	Battery fully charged (terminate current $\leq 300 \pm 100$ mA)
Slow Flash	OFF	Pre-charge mode
Red and green LEDs flash synchronously		Pre-charge mode fail
Red and green LEDs quickly flash alternately		Overvoltage • Overcurrent • CC • CV mode current fail

MECHANICAL SPECIFICATION:

1. Dimension: 167*4*37 mm.
2. Weight: 410g approx.
3. Charger output: 3-pin connector (Pin 1-Positive; Pin 2-Negative; Pin 3-Negative).
4. AC socket: Standard 2-p oblong.
5. AC cable: National wall plug type upon request.

OPERATION PROCEDURES:

1. Attention! Connect charger first to AC power **before** connecting the battery to the charger. Plug into AC main. The power on indicator will be ON and the status indicator will be GREEN. Then connect the battery pack to charger.
2. During charging, the status indicator turns RED. When full, it turns GREEN.
3. To avoid the case of failed battery pack, when the charger stays in pre-charge stage longer than 1 hour, it will stop charging and the status indicator will pulse for one second to indicate pre-charge error.
4. During charging, user can remove the battery from charger anytime he/she wants. User can also start to charge the battery at anytime. The charger is able to determine the best cut-in point during the charging process.
5. In case of problems, please check battery pack and repeat above steps. If problems persist, please contact METCO for assistance.

CHECK BEFORE PROCEEDING:

1. Make sure battery pack is compatible with NL07C before connecting.
2. The 3-pin connector of the output cable is preset at the factory. Do not swap their connections which may cause serious hazards.
3. NL07C charger is designed for use only with METCO battery packs and is not recommended for use with other battery packs. Battery packs from other manufacturers must be approved by METCO before using this charger to charge.
4. NL07C is a precise tool and should be kept away from high power EMI radiating devices.

ATTENTION!!

Never use this charger to charge a non-rechargeable battery.



Specification of Li-ion Charger (MODEL:LS-018C20-2402500)

DESCRIPTION:

LS-018C20-2402500 is a smart charger specially designed for Li-ion battery pack composed of cells in the series.

ELECTRICAL SPECIFICATIONS:

1. Input: 100–240VAC, 50/60 Hz Output; 29.4V ± 0.2V 2.5A_{dc}±10%
2. Charger output: The charger is preset by the factory for charging 7 cells in this Li-ion battery pack.
Charging mode:
 - (1) Constant current (CC) mode: at beginning of charging, an 2.5A_{dc}±10% (I_{ave}) constant charging current to charge the pack until the pack voltage reaches to 29.4V±0.2V
 - (2) Constant Voltage (CV) mode: the output will keep 29.4V±0.2V constant through the end of charging.
 - (3) Pre-charge state: When battery voltage is lower than 21V±1V, will start the pre-charge first. The charge-current is 20% of CC charge current: 0.5A_{dc}±10%.
 - (4) Re-charge static: When fully-charged battery voltage drops lower than 28.3V±0.5V, the charger will start a new charge cycle.
3. The indicator signal chart:

Signal / Indicator	POWER (bi-color LED)	STATUS (dual color LED)
<ul style="list-style-type: none">• Stand by• End of charge	Constant RED	Constant GREEN
<ul style="list-style-type: none">• Pre-charge state• Charge state	ON	Constant RED
<ul style="list-style-type: none">• Overcurrent• Overvoltage• Over temperature	ON	Flash between RED and GREEN every second
<ul style="list-style-type: none">• Zero voltage pre-charge state• Short circuit	ON	Flash between RED and GREEN RED: 16ms; GREEN: 496ms

ATTENTION!!

Never use this charger to charge a non-rechargeable battery.

MECHANICAL SPECIFICATION:

1. Dimension: 160*86*55 mm.
2. Weight: 510g approx.
3. Charger output: 3-pin connector (Pin 1-Positive; Pin 2-Negative; Pin 3-XXX).
4. AC socket: Standard 2-p oblong.
5. AC cable: National wall plug type upon request.

OPERATION PROCEDURES:

1. Attention! Connect charger first to AC power **before** connecting the battery to the charger. Plug into AC main. The power on indicator will be ON and the status indicator will be GREEN. Then connect the battery pack to charger.
2. If short circuit at output is found, the status indicator will flash between RED (16ms) and GREEN (496ms). The flash will be there until the system is reset and the short part is removed.
3. During charging, the status indicator turns RED. When full, it turns GREEN.
4. To avoid the case of failed battery pack, when the charger stays in pre-charge stage longer than 5 hours, it will stop charging and status indicator will pulse for one second to indicate pre-charge error.
5. During charging, user can remove the battery from charger any time he/she wants. User also can start to charge the battery at any time. The charger is able to determine the best cut-in point during the charging process.
6. In case of problems, please check battery pack and repeat above steps. If problems persist, please contact STL for assistance.

CHECK BEFORE PROCEEDING:

1. Make sure battery pack is compatible with LS-018C20 before connecting.
2. The 4-pin connector of the output cable is pre-set at the factory. Do not swap their connections. This may cause serious hazards.
3. LS-018C20 charger is designed for use only with STL battery packs and is not recommended for use with other battery packs. Battery packs from other manufacturers must be approved by STL before using this charger to charge.
4. LS-018C20 is a precise tool and should be kept away from high power EMI radiating devices.

ATTENTION!!

Never use this charger to charge a non-rechargeable battery.

ACI SUPER POWER™

Lead-Acid Class II Battery Charger Owner's Manual

Model: ACI245000
24V, 5.0A
VALA / SLA / AGM / Gel Cell

SAVE THESE INSTRUCTIONS
This manual contains important safety
and operating instructions.

GENERAL INFORMATION

ACI245000 battery charger is an automatic, three-stage battery charger. It is designed to properly charge VALA/ SLA /AGM /Gel Cell lead-acid batteries. With optimized algorithm that ensures the batteries receive optimum charging from the delivery of an accurate three-stage charge cycle, ACI245000 charger provides a lasting, safe and complete charge, without risk of over-charging and battery damage. It can be used in all parts of the world with its universal AC power input design (100-240 VAC). The dual LED indicators display updates to the user in real time, for the charging status and battery condition.

OPERATING INSTRUCTIONS

LED INDICATORS

LED		Charge Status
Power Charge	Red Red	AC poor connected Battery fast charging
Power Charge	Flash Red Green	AC power connected Reverse polarity connection
Power Charge	Red Green	AC power connected Battery fully charged

CAUTION: If the charge LED remains RED for more than 24 hours, unplug the charger from AC power and check the batteries, there may be a problem with the batteries, call for service if needed.

CHARGING

- Before use, read all instructions and cautionary markings on charger, battery and any mobility aid device.
- Turn off all accessories on mobility aid device.
- Make sure to place the charger in a safe and clean environment on a dry, nonflammable surface.
- Connect the charger DC output plug to the port on the mobility aid device. Connect the charger AC plug to an electrical outlet.
- The charger will start to charge the battery automatically. If the power LED does not illuminate, please check the connections.
- To disconnect, reverse the procedures.

CHARGING

For 24V battery, if the battery voltage is less than 10 VDC, the charger will not charge.

SPECIFICATIONS

INPUT

100 • 240VAC, 50/60 Hz, 170W OUTPUT

OUTPUT

24 VDC, 5.0A

DIMENSIONS

Length	169.3 mm / 6.67 in
Width	136.6 mm / 5.38 in
Height	82.5 mm / 3.25 in
Weight	0.96 kg / 2.12 lb

SAFETY LISTINGS

CE / ETL / C-Tick

CHARACTERISTICS

Universal AC Input	100 – 240V, 50–60Hz, 170 W
Maximum Output	29 VDC, 5.0 A
Standby Power	4 W

CHARGE STAGES

STAGE	CURRENT (AMP)	VOLTAGE (VDC)
Fast Charge	5.0	10 - 29
Absorption	5.0 - 1.0	29
Float Charge	1.0 - 0.2	27

PROTECTIONS

- Multiple reverse polarity protection
- Over load protection
- Short circuit protection

IMPORTANT SAFETY INSTRUCTIONS

CAUTION

For charging VALA, SLA, AGM, Gel/LEAD-ACID battery only
Recommended for 18 - 55 Ah battery
For indoor use only

WARNING AND SAFETY NOTES

To reduce the risk of the battery explosion and electric shock:

- Follow these instructions and those published by the battery manufacturer and the manufacturer of mobility aid device.
- Disconnect from AC power before cleaning.
- Make sure battery is clean and property connected.
- Never charge a frozen battery.
- Never overcharge a battery.

DO NOT disassemble the charger, it must be serviced by a qualified technician.

Keep the charger away from dust, damp, rain, heat, direct sunshine and vibration.

DO NOT drop the charger.

Keep out of reach of children.

Operation is subjected to the following conditions: (1) This device may not cause harmful interference, and (2) this device must accept any interference received, including interference that may cause undesired operation.

WARRANTY

The warranty of the charger is for a period of one year from date of purchase at retail against defective material or workmanship that may occur under normal use and care. The charger will be replaced or repaired at manufacturer's discretion. Proof of purchase is required.



ACROSS CHINA (USA), INC.
400 Andrews Street, Suite 360
Rochester, NY, 14604
www.acrosschinausa.com

BATTERY CHARGER INSTRUCTIONS - ENGLISH

APPEARANCE

1. Power Cord
2. Output Plug to Battery
3. Indicator:
 - Green Flash: Power On
 - Orange Flash: Pre-Charge
 - Orange: Charging
 - Green & Orange Flash: Charged 80%
 - Green: Full Charge
 - Red Flash: Defect

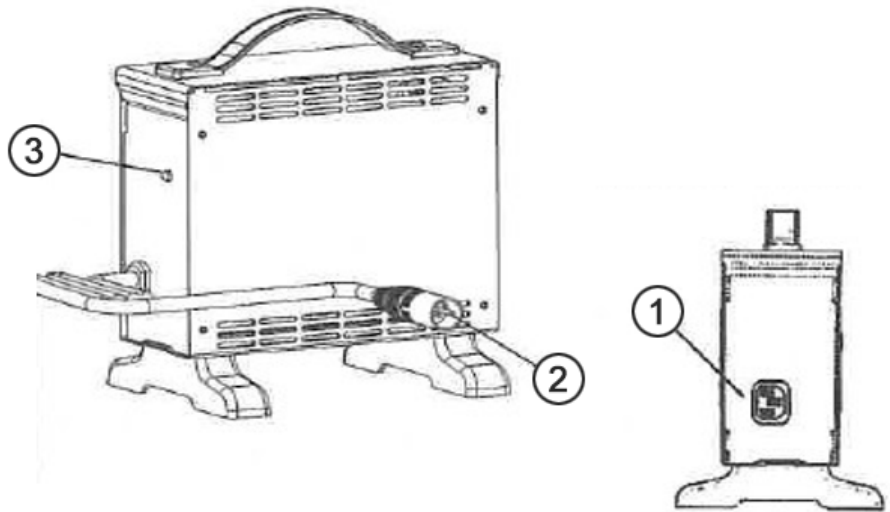

SPECIFICATIONS

ITEM	BATTERY CHARGER (SWITCHING MODE)
Model	4C24080A
Output Current (DC)	8A±5%
Charging Voltage (DC)	28.8V±0.2V
Floating Voltage (DC)	27.6V±0.2V
Input Current (AC)	3.8A max.
Input Voltage (AC)	100 ~ 240 V 50/60Hz
Efficiency	AC-DC 85% min
Operating Temperature	-25°C ~ 40°C
Switching Method	SWITCHING MODE
Charging Method	Constant current two stage constant voltage
Battery Application	24V Lead Acid Rechargeable Battery (26Ahr -75Ahr)
Output Detection	1. Short Circuit Protection 2. Reverse Power Protection 3. Overheat Protection 4. Charging Plug Protection
Operating Humidity	20% ~ 85%
Measure	(L) 180mm x (W) 130mm x (H) 195mm
Weight	1.7 kg
Color	Black

OPERATING INSTRUCTION

- (1) Make sure the battery charger output voltage is the same as the connecting battery.
- (2) Plug in the power cord. LED indicator flashes green when AC power on.
- (3) Connect the battery charger to the battery.
- (4) Start charging; please refer to 4, LED INDICATION.

LED INDICATION

- (1) Green flash: power on
- (2) Orange: charging
- (3) Orange flash: precharge
- (4) Green & orange flash: charged 80%
- (5) Green: full charged (floating charge)
- (6) Red flash: defect

TROUBLESHOOTING

- (1) If green indicator is off:
 - Check AC input. If it works normally, the battery charger may be defective.
- (2) If green indicator keeps flashing, can't turn to charging indication:
 - Check if the battery connects successfully.
 - Check if the output connection is short or open.
 - If the battery connection is normally, the battery charger may be defective.
- (3) If red indicator keeps flashing:
 - Check if the battery connection is reversed.
 - Check if the output connection is short or open.
 - Check if the environment temperature is too low (-25°C).
 - If the red indicator still keeps flashing, the battery charger may be defective.
- (4) Charging indicator (orange) can't turn to green:
 - The battery might be defective. Please stop charging and have the battery repaired.
- (5) If the charging indicator (orange) turns green (fully charged) immediately:
 - The battery may be in well-charged condition.
 - If the battery is not fully charged, the battery may be defective.

CAUTION

- (1) Before using the battery charger, read all instructions and cautionary markings.
- (2) Use the battery charger in a well-ventilated area.
- (3) To avoid the risk of injury, charge only lead-acid or gel cell type rechargeable batteries.
- (4) Please turn off the power after charging.



HIGH POWER TECHNOLOGY (KunShan) INC

**Battery Charger Instructions
for iRIDE™ Scooter**

HP1202L3 (2A/1.5A)

1. Operating Instructions

- (1) Make sure the power cord, charger and battery connector are in good condition.
- (2) Make sure the output voltage of the charger is the same as the connecting battery.
- (3) Connect the plug of the charger with the battery, and then plug the AC power plug into the electricity outlet.

2. LED indicators:

Blue light on: Power on. Disconnect the battery.

Red light on: Charging.

Green light on: Fully charged.

3. Troubleshooting

- (1) Blue light is off when power is on:

Check if the input power cord of the charger is plugged into the socket, and whether electricity passes through from the outlet. If yes, please send the charger for repair.

- (2) Red light is off during charging:

Check if the charger and battery connectors are connected correctly. If they have a good connection, and the battery is not fully charged, the battery may be defective.

- (3) Red light turns to green immediately:

Check to see if the battery is fully charged. If it is not fully charged, the charger may be defective. Please send the charger back to the manufacturer for repair.

4. Caution

- (1) For indoor use only. Do not expose to rain.
- (2) Please switch off the power supply before removing the charger from the battery.
- (3) Do not get close to explosive gases or sparks and put the charger in a well-ventilated area during charging.
- (4) Use the charger only with 36V (Vmax:42V) lithium batteries.



OWNER'S MANUAL
24V 3.5A Lithium Charger
Model No: 24BC3500L-1
Part No. ELE2008644

SAFETY STANDARDS: UL, cUL, CE, GS, C-tick, SAA, FCC

FCC STATEMENT

This device complies with Part 15 of the FCC rules. Operation is subject to the following two conditions: (1) This device may not cause harmful interference. and (2) This device must accept any interference received, Including Interference that may cause undesired operation.

NOTE: This equipment has been tested and found to comply with the limits for a Class B digital device, pursuant to Part 15 of the FCC rules. These limits are designed to provide reasonable protection against harmful interference in a residential installation. This equipment generates, uses, and can radiate radio interference energy and, if not installed and used in accordance with the instructions, may cause harmful interference to radio communications. However, there is no guarantee that interference will not occur in a particular installation. If this equipment does cause harmful interference to radio or television reception, which can be determined by turning the equipment off and on, the user is encouraged to try to correct the interference by one or more of the following measures:

- Re-orient or relocate the receiving antenna.
- Increase the separation between the equipment and the receiver.
- Connect the equipment into an outlet or on a circuit different from that to which the receiver is connected.
- Consult the dealer or an experienced radio/TV technician for help.

IMPORTANT SAFETY INSTRUCTIONS

SAVE THESE INSTRUCTIONS:

This manual contains safety and operating instructions for your charger. Before using your charger, read all instructions and cautionary markings on the battery charger, and the product using the battery.

CAUTION: *To reduce the risk of injury, charge only Lithium batteries. Other types of batteries may burst, causing personal injury and damage.*

WARNINGS:

- Do not allow children to operate charger without supervision. Keep out of the reach of children.
- Do not disassemble the charger. Have it serviced or repaired by qualified service personnel. Incorrect assembly can result in risk of electric shock or fire.
- Never use the charger as a DC power source for any electrical equipment.
- Never operate a charger with a damaged cord or plug. Inspect both input and output cords for any damage before using the charger.
- Never unplug a cord by pulling on the cord itself. Always grasp the plug when disconnecting the charger.
- For indoor use only. Do not expose charger to rain, snow or excessive moisture.
- Never charge a frozen battery.
- The battery must be placed in a well-ventilated area during charging.

CHARGING A BATTERY:

Follow these steps to charge a battery:

1. Connect the charger DC output cable to the battery charge receptacle.
2. Plug the charger power cord into the charger.
3. Plug the power cord into wall outlet.
4. The POWER LED and CHARGING LED light should be ON.
5. When batteries are fully charged, the CHARGING LED will be steady GREEN.
Unplug the charger from the wall, then the battery receptacle.
6. If urgent usage becomes necessary, it is acceptable to terminate the charge cycle.

LED INDICATORS:

Description	LED
Power On	ON
No AC Power	OFF

CHARGING FAULTS (Dual-color LEDs)

Descriptions	Red LED	Green LED
No Battery	OFF	OFF
Bulk/Absorption Charge	On	OFF
Full Charge (Charge Current < 500mA)	OFF	Solid On
12-hour Clock Timeout	Continuous Blinking (2Hz)	OFF
Low Battery Voltage Batteries at 9~14V)	1 blink every 3 seconds	OFF
Reverse-Polarity Connection	2 blinks every 3 seconds	OFF
Over-voltage Fault	3 blinks every 3 seconds	OFF
Over-current Fault	4 blinks every 3 seconds	OFF

TWO STAGE CHARGE CYCLE:

For Lithium Ion batteries the charger provides 2 stage charging.

1. **A high current, fast charge state:** battery charges at 3,500mA fast charge current rate until battery voltage of 28.8 V is reached.
2. **A topping charge state:** battery charges at peak constant voltage and current begins to fall until current is less than 500mA.

FAULTS:

1. **Overcurrent protection** – protects the charger from overcurrent demand.
2. **Overvoltage protection** – protects the batteries from damage.
3. **Battery polarity reversal** – protects the charger and batteries against incorrectly installed batteries.
4. **Short-circuit protection** – protects the charger from short-circuit damage.

SPECIFICATIONS

Input Voltage	100-240Vac +/-10%
Input Frequency	50-60 Hz
Output Voltage Fast Charge (Bulk}	DC 28.8V ±0.2V
Output Current Fast Charge (Bulk}	DC 3,500mA
Operating Temperature	32 F/-0 C to +104 F/40 C
Storage Temperature	-4 F/-20 C to +140 F/60 C
Battery Capacity	8Ah - 35Ah
Power Supply Cord	SJT, 18AWGX3C, 300V, 105°C
Connector Pins	PIN 1 - 24VDC PIN 2 - Ground PIN 3 - Inhibit

LIMITED WARRANTY STATEMENT

Universal Power Group (UPG) warrants your unit to be free from defects in material and workmanship for a period of 1 year from the date of sale to the original user or purchaser. This warranty is non-transferable. If your unit malfunctions or fails within the 1 year period because of a defect in material or workmanship, we will replace or repair the unit. Replacement will be made with a new or re-manufactured product or component. If the product is no longer available, replacement may be made with a similar product of equal or greater value.

This warranty excludes malfunctions or failure of your unit caused by repairs made by an unauthorized person, mishandling, modifications, normal wear, unreasonable use, or damage to the product.

This warranty is in lieu of all other express warranties. The duration of any implied warranty, including but not limited to any implied warranty of merchantability or fitness for a particular purpose, made in respect to your unit is limited to the period of the express warranty set forth above.

In no event shall UPG be liable for consequential or incidental damages. Some states do not allow limitations on the length of implied warranty or the exclusion or limitations of incidental or consequential damages, so the above limitations or exclusions may not apply to you. This warranty gives you specific legal rights and you may also have other rights, which vary from state to state.

If you have technical questions, please send inquiries to:

technicalsupport@upgi.com

Warranty Process

Please contact your retailer or place of purchase for warranty service and instructions.

A proof of purchase will be required.



24V 8A
Lithium Battery Charger
Owner's Manual

Model No:
24BC8000L-1

Features:

Complete Charging Process - Bulk charge, absorption

Short Circuit Protection - Prevents damage caused when operating in short circuit condition for an indefinite period of time. The charger is "self-recovering" when the fault condition is removed.

Reverse Polarity Protection - Prevents damage when positive and negative polarities are connected in reverse.

Fully Automatic Operation - Safely charges and maintains a full charge.

Low Voltage Protection - When the battery voltage is below a preset value the charger will not start charging.

LED Display - 2 LED displays indicate ON / OFF and Charge-State / Faults.

Light Weight - Switch mode chargers are lighter and more efficient than linear type chargers.

IMPORTANT SAFETY INSTRUCTIONS

Save These Instructions

This manual contains safety and operating instructions for your charger. Before using your charger, read all instructions and cautionary markings on the battery charger, and the product using the battery.

CAUTION: To reduce the risk of injury, charge only Lithium batteries. Other types of batteries may burst causing personal injury and damage.

WARNINGS:

- Do not allow children to operate charger without supervision. Keep out of the reach of children.
- Do not disassemble the charger. Have it serviced or repaired by qualified service personnel. Incorrect assembly can result in risk of electric shock or fire.
- Never use the charger as a DC power source for any electrical equipment.
- Never operate a charger with a damaged cord or plug. Inspect both input and output cords for any damage before using the charger.
- Never unplug a cord by pulling on the cord itself. Always grasp the plug when disconnecting the charger.
- For indoor use only. Do not expose charger to rain, snow or excessive moisture.
- Never charge a frozen battery.
- Always place the battery in a well ventilated area during charging.

SAFETY STANDARDS: UL, cUL, CE, C-tick, SAA, FCC

FCC STATEMENT

This device complies with Part 15 of the FCC Rules. Operation is subject to the following two conditions: (1) This device may not cause harmful interference, and (2) This device must accept any interference received, including Interference that may cause undesired operation.

NOTE: This charger has been tested and found to comply with the limits for a Class B digital device, pursuant to Part 15 of the FCC rules. These limits are designed to provide reasonable protection against harmful interference in a residential Installation. This charger generates, uses, and can radiate radio interference energy and, if not installed and used In accordance with the Instructions, may cause harmful interference to radio communications. However, there is no guarantee that Interference will not occur In a particular installation. If this charger does cause harmful interference to radio or television reception, which can be determined by turning the charger off and on, the user is encouraged to try to correct the Interference by one or more of the following measures:

- Re-orient or relocate the receiving antenna.
- Increase the separation between the equipment and the receiver.
- Connect the equipment into an outlet or on a circuit different from that to which the receiver is connected.
- Consult the dealer or an experienced radio/TV technician for help.

LIMITED WARRANTY STATEMENT

Universal Power Group (UPG) warrants your unit to be free from defects in material and workmanship for a period of 1 year from the date of sale to the original user or purchaser. This warranty is non-transferable. If your unit malfunctions or fails within the 1 year period because of a defect in material or workmanship, we will replace or repair the unit. Replacement will be made with a new or remanufactured product or component. If the product is no longer available, replacement may be made with a similar product of equal or greater value.

This warranty excludes malfunctions or failure of your unit caused by repairs made by an unauthorized person, mishandling, modifications, normal wear, unreasonable use, or damage to the product.

This warranty is in lieu of all other express warranties. The duration of any implied warranty, including but not limited to any implied warranty of merchantability or fitness for a particular purpose, made in respect to your unit is limited to the period of the express warranty set forth above.

In no event shall UPG be liable for consequential or incidental damages. Some states do not allow limitations on the length of implied warranty or the exclusion or limitations of incidental or consequential damages, so the above limitations or exclusions may not apply to you. This warranty gives you specific legal rights and you may also have other rights, which vary from state to state.

If you have technical questions, please send inquiries to:

technicalsupport@upgi.com

Warranty Process

Please contact your retailer or place of purchase for warranty service and instructions.

A proof of purchase will be required.

Charging a Battery:

Follow these steps to charge a battery:

1. Connect the charger DC output cable to the "battery charge" receptacle on the product to be charged using the magnetic connector. An **LED** on the connector will illuminate signifying that a secure connection has been made and is ready for charging.
2. Plug the charger power cord into the charger.
3. Plug the power cord into wall outlet.
4. The **Power LED** and **Charging LED** light on the charger should be **ON**.
5. When batteries are fully charged, the **Charging LED** will be steady **GREEN**. Unplug the charger from the wall, then the battery receptacle.

Note: Short interval charging is acceptable with Lithium-ion batteries and will help the performance and longevity of the battery.

Two Stage Charge Cycle:

For Lithium Iron Phosphate (LFP) batteries the charger provides two stage charging.

1. **A High Current Fast Charge State:** battery charges at 8,000mA fast charge current rate until battery voltage of 28.8V is reached
 2. **A Topping Charge State:** battery charges at 28.8V constant voltage and current begins to taper until current is less than 500mA.
-

Protections:

- **Over Current Protection** - protects the charger from overcurrent demand.
- **Over Voltage Protection** - protects the batteries from damage.
- **Battery Polarity Reversal** - Protects the charger and batteries against positive and negative polarities being connected in reverse.
- **Short Circuit Protection**

Two LEDs for Status Inductation:

1. Power LED (Red)

DESCRIPTION	LED
Power On	On
No AC Power	Off

2. Charging / Faults LED (Dual-Color)

DESCRIPTION	RED LED	GREEN LED
No Battery	Off	Off
Bulk/Absorption Charge	On	Off
Full Charge (Charge Current<500mA)	Off	Solid On
12-hour Clock Timeout	Continuous Blinking (2Hz)	Off
Low Battery Voltage (Batteries at 9-17V)	1 Blink every 3 seconds	Off
Reverse - Polarity Connection	2 Blink every 3 seconds	Off
Over - Voltage Fault	3 Blink every 3 seconds	Off
Over - Current Fault	4 Blink every 3 seconds	Off

NOTE: To comply with the DOE mandate this charger automatically stops charging after 20 hours of continuous operation. However, if left connected to batteries, the charger monitors the batteries with an auto-restart function to keep batteries fully charged.

Specifications:

Input Voltage	100-240Vac +/-10%
Input Frequency	50-60 Hz
Output Voltage Fast Charge (bulk)	DC 28.8V± .2V
Output Current Fast Charge (bulk)	DC 8,000mA ±10%
Operating Temperature	32°F/0°C to +104°F/40°C
Storage Temperature	-4°F/-20°C to +140°F/60°C
Battery Capacity	16Ah - 100Ah
Power Supply Cord	SJT, 18AWGX3C, 300V, 105°C